

Hino 300 815 AT SWB

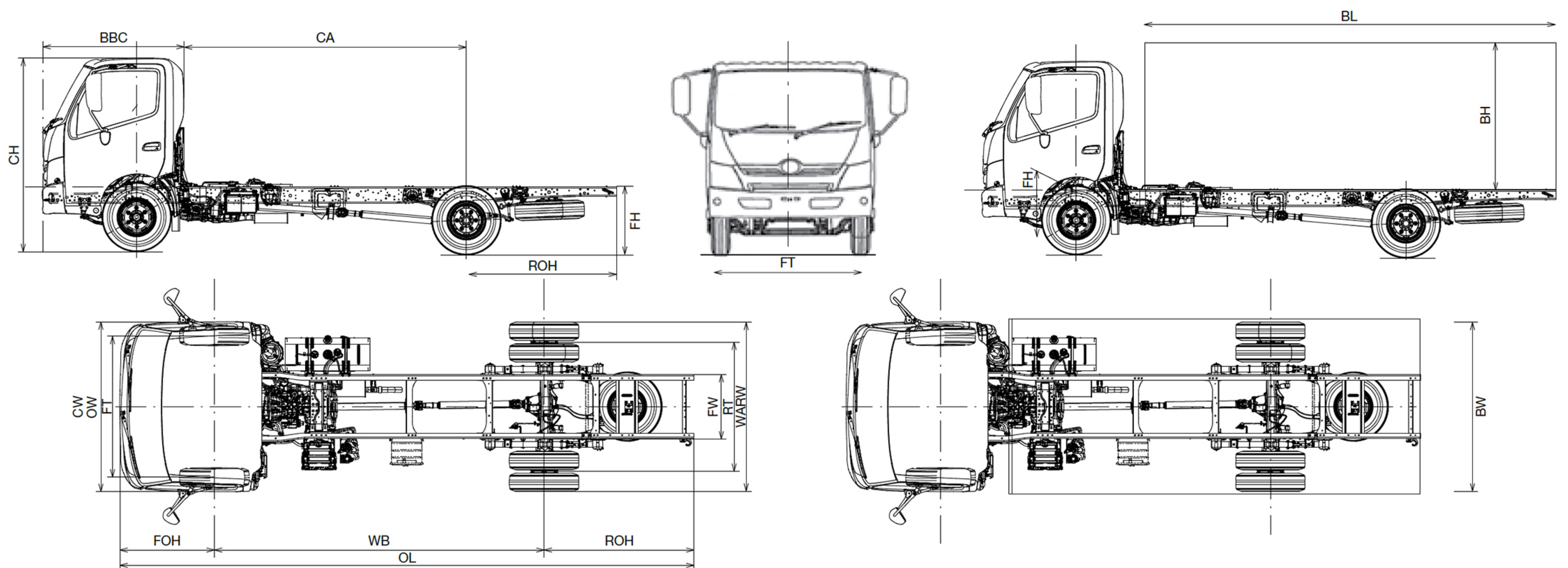

CHASSIS +



SPECIFICATIONS	DIMENSIONS (mm)
BBC - Rear Structure	1670
CA - Cab to Axle	3310
CH - Cab Height	2220
CW - Cab Width (excl. mirrors)	1995
FH - Frame Height @ Rear Axle	815
FOH - Front Overhang	1110
FT - Front Track	1655
FW - Frame Width (Outside)	750
Max. homologated body width	1995 - 2500
Maximum Body Length	5600
Suggested Body Length	5200
Minimum Ground Clearance	215
OL - Overall Length	6735
OVH - Overall Vehicle Height	2220
ROH - Rear Overhang	1760
RT - Rear Track	1520
WARW - Width Across Rear Wheels	1985
WB - Wheel Base (FAS+WB+RAS)	3870
WB - Wheel Base (Min - Max)	3430 - 4800